

## T7208 Telephone User Card

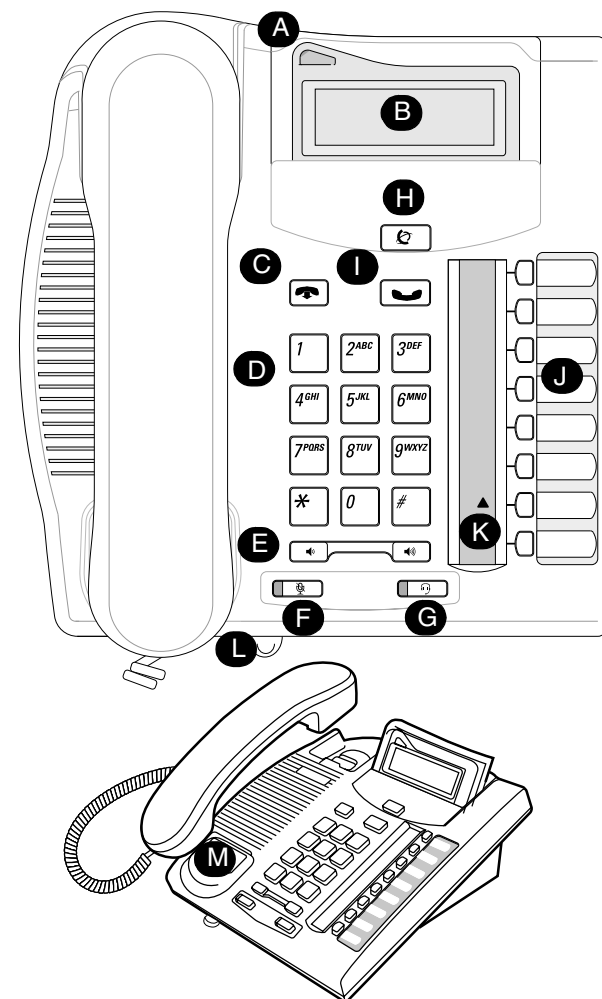

1-800-4 NORTEL  
www.nortelnetworks.com  
© 2004 Nortel Networks  
P0609622 01  
Printed in Canada



### Cord connections

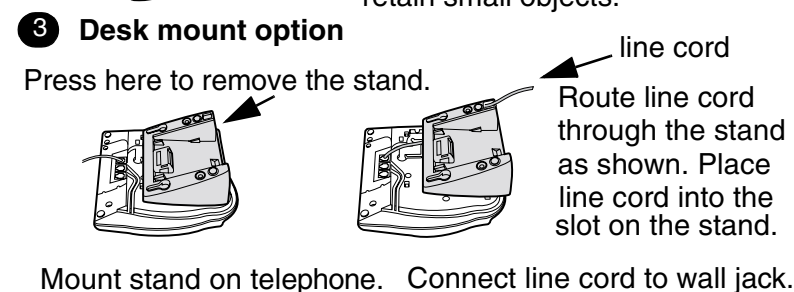
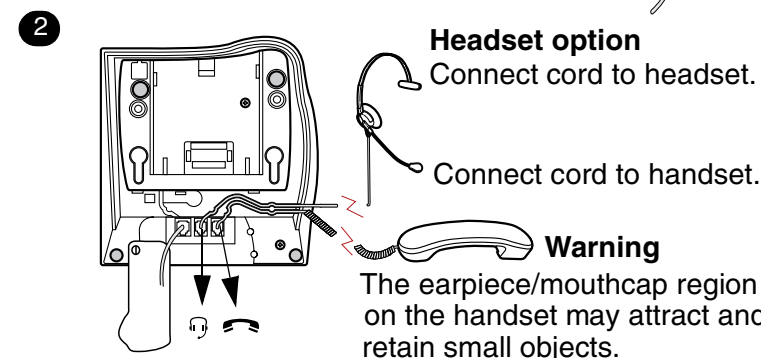
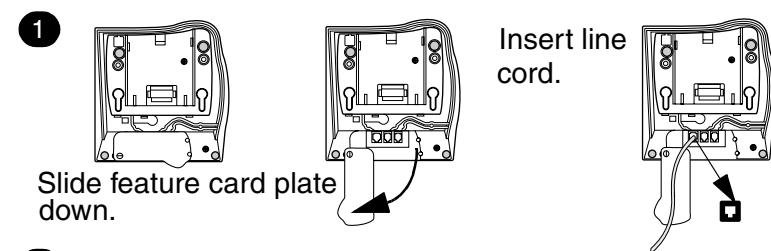

### Wall mount without a telephone stand

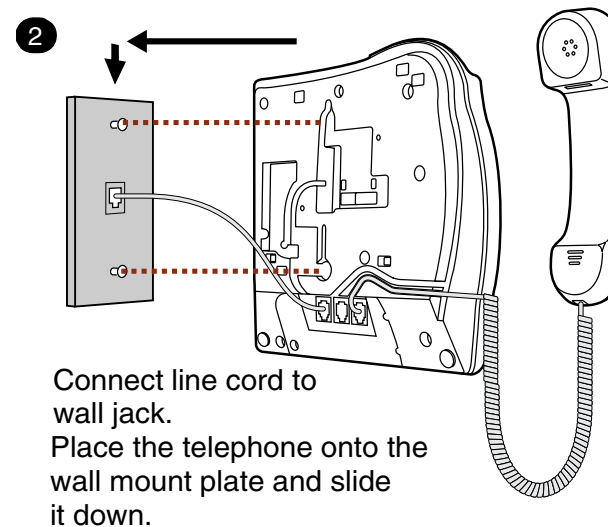
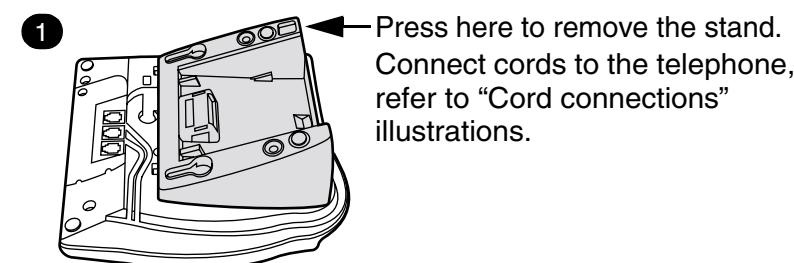

### Wall mount with a telephone stand

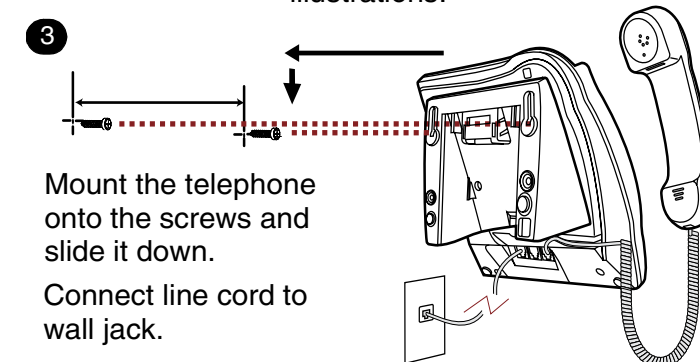
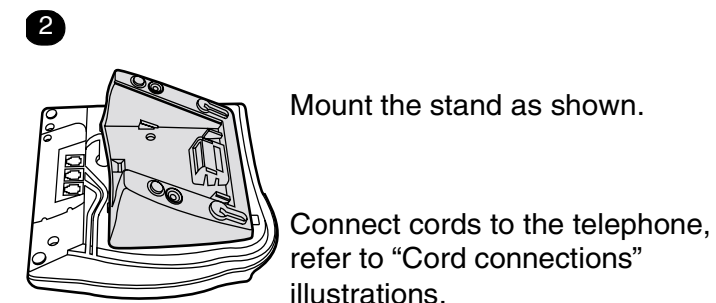
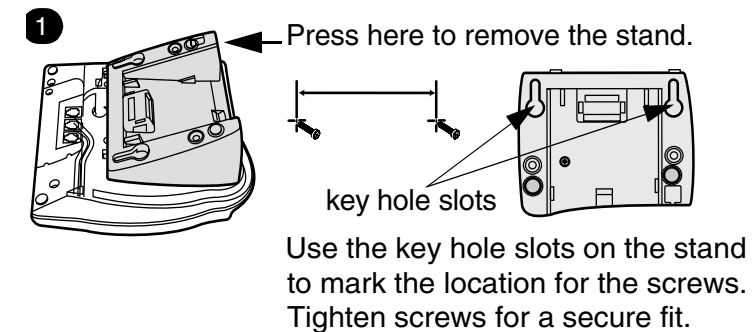

### Telephone setup

#### Display contrast level

Adjust the contrast of your display.

1. Press **[☎] \* 7**.
2. Press **[1]** to **[9]** to select a contrast level. The higher the number the higher the contrast level.

#### Language choice

- [☎] \* 5 0 1**  
Select Primary Language for the telephone display.
- [☎] \* 5 0 2**  
Select Alternate Language for the telephone display.
- [☎] \* 5 0 3**  
Select Alternate Language 2 for the telephone display.
- [☎] \* 5 0 4**  
Select Alternate Language 3 for the telephone display.

#### Ring type

Select a different ring for your telephone.

1. Press **[☎] \* 6**.
2. Press **[1]**, **[2]**, **[3]**, **[4]** to hear the different ring types.
3. Press **[☎]** to store the ring type.

### Your T7208 telephone

#### A Telephone light

Flashes for incoming calls.

Lights up when Message Waiting Indication (MWI) is supported by system software. Contact your system administrator for more information.

#### B Adjustable display

Shows the time and date, call and feature information. Adjust the display to your personal preference.

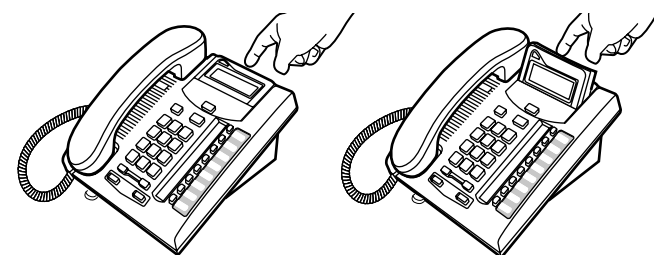

#### C Release button

Ends an active call or feature.

#### D Dial pad

#### E Volume control

Adjusts the handset, handsfree, headset and ringer volume.

### Your T7208 telephone

#### F Mute button

Turns the microphone off or on when you are on a call.

#### G Headset button

Turns the headset mode on.

#### H Feature button

Starts or ends a feature.

#### I Hold button

Places calls on hold.

#### J Memory and line buttons

#### K Indicators

Appear next to active line and memory buttons.

#### L Feature card plate

Storage compartment for your feature card.

#### M Number card

Write your extension number on this card.

## Button inquiry

Check what is programmed on your buttons.

1. Press .
2. Press the button(s) that you want to check.
3. Read the display. Button assignment examples are shown below.

<b>Line</b> XXX (LINENAME)	<b>Intercom</b> XXXX (SETNAME)
<b>Internal autodial</b> Autodial (XXXX)	<b>External autodial</b> (XXXXXXXXXX)
<b>Feature</b> (FEATURENAME)	<b>Handsfree</b> Handsfree

4. Press when finished.

## Button labels

Use the button label strip on the telephone to show what is programmed on the buttons. Spare button label strips are provided with your telephone.

### How to label your buttons

1. Remove the plastic lens and button label strip from the telephone.
2. Write the name of each button on the button label strip.
3. Insert the button label strip back on the telephone.
4. Insert plastic lens, matching the tabs on the lens with the notches on the telephone.

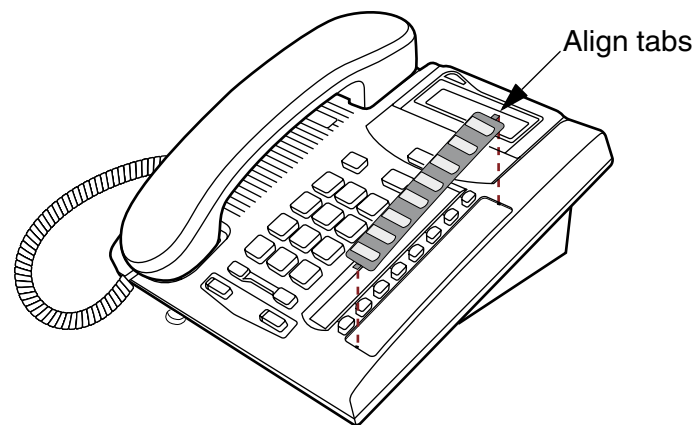

### Tip

Use the Desktop Assistant application to customize button label strips for your telephone.

Go to [www.nortelnetworks.com](http://www.nortelnetworks.com) and download the Desktop Assistant application to your personal computer.

## Memory buttons

Memory buttons are buttons with ▲ indicators not assigned as line, intercom or handsfree buttons. Memory buttons store internal and external numbers or features to give you one touch dialing or feature activation.

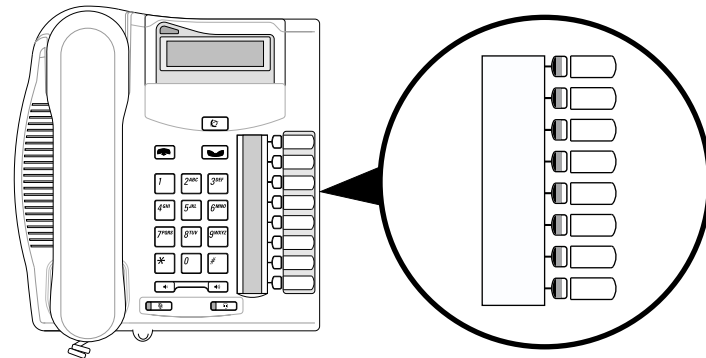

## Programming memory buttons

You can program a memory button with a new number or feature.

### External autodial

1. Press .
2. Press a memory button.
3. Dial the external number.
4. Press to store the number.
5. Label your new button.

### Internal autodial

1. Press .
2. Press a memory button.
3. Dial the extension number.
4. Label your new button.

### Features

1. Press .
2. Press a memory button.
3. Press and enter the feature code.
4. Label your new button.

### How to erase memory buttons

1. Press .
2. Press a memory button.
3. Press to erase the button.

## Making and answering calls

### Making calls

There are many ways to make a call, depending on your telephone programming and the type of call.

#### External calls using line buttons

1. Lift the handset.
2. Press a line button.
3. Dial the external telephone number.

#### External calls using intercom buttons

1. Lift the handset.
2. Press an intercom button and enter a line pool access code.
3. When you hear an external dial tone, dial the external telephone number.

Contact your system administrator for a list of line pool codes.

#### Internal calls using intercom buttons

1. Lift the handset.
2. Press an intercom button.
3. Dial the extension number.

Contact your system administrator for a list of extension numbers.

### Answering calls

When your telephone rings and the display light flashes or when an intercom or line button ▲ indicator flashes:

- Lift the handset.  
OR  
Press the button with the flashing ▲ indicator before you lift the handset.

### How to hold calls

- While on a call, press . The ▲ indicator for the line on hold will flash.
- To retrieve a held call, press the line button with the flashing ▲ indicator.
- Calls are put on hold automatically when you switch from one line to another.

## More on making and answering calls

### Handsfree calls

Your system administrator must program the handsfree feature on your telephone.

- Press the handsfree button on your telephone to make or answer a call.
- To switch to handsfree when you are on a call, press the handsfree button and replace the handset. Lift the handset to switch back.

When programmed, the handsfree feature is assigned to button 8 on your telephone.

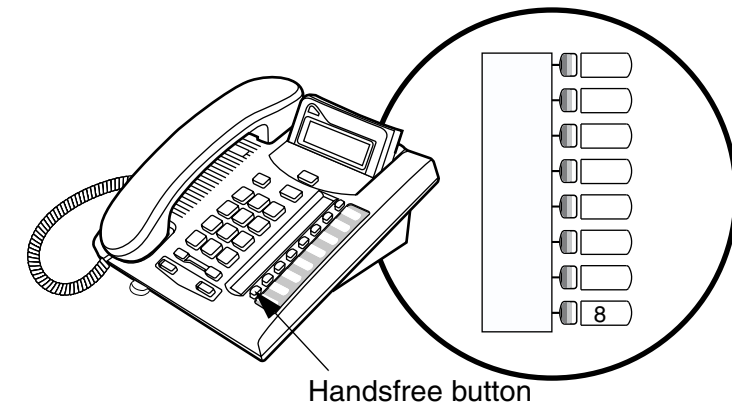

Handsfree button

### How to mute calls

- While on a call, press to turn the microphone off. The light flashes when the microphone is off.
- Press again to turn the microphone on.
- Use on handset, handsfree or headset calls.

### Headset calls

- Press to activate the headset mode. When the light is on, press a line or intercom button to make a call.
- Press to answer a call when the telephone rings or when an intercom or line button ▲ indicator flashes.
- To switch to your headset when you are on a call, press and replace the handset. Lift the handset to switch back.

### Warning

Nortel Networks does not support the connection of a headset to the T7208 telephone, unless handsfree is enabled within the system programming. If handsfree is not enabled, certain call handling features may not work as intended.